

---

# **KNIGHT**

## **IDEX**

IDEX CORPORATION

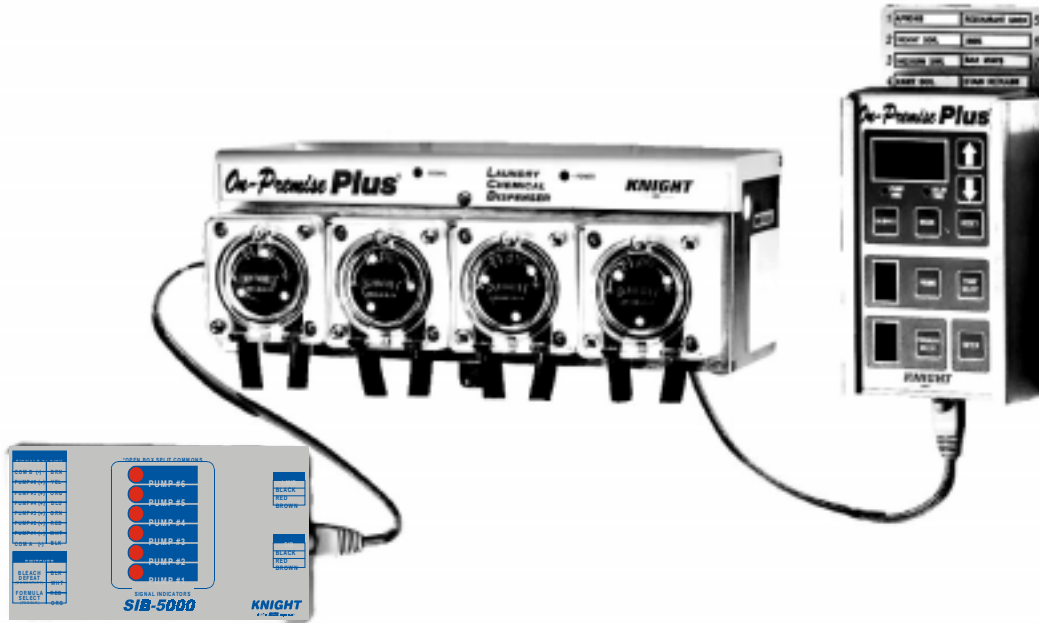

# **On-Premise Plus**

# **Instruction Manual**

---

## TABLE OF CONTENTS

Quick-Start Programming .....	3
Introduction .....	4
Features .....	4
Pre-installation .....	5
Installation .....	5
Operating Modes .....	6
Programming .....	7
Load Counts .....	10
Drain Mode .....	11
Other Features .....	12
Troubleshooting .....	14
System Wiring Diagram .....	15
Warranty Information .....	16
Knight Locations .....	16

## QUICK-REFERENCE

Listed below is a guide for quickly setting features that are explained in detail throughout this manual. As a reminder, you must have access (enter access code) to change any of the settings.

<b>Setting</b>	<b>Formula #</b>	<b>Pump #</b>	<b>Range/Choice</b>
Access code	A	1	0 – 255
Signal lockout time	A	2	0 – 75 minutes
Delay units	A	3	1 = seconds      60 = minutes
Pump 7 & 8 enable	A	4	0 = disabled      1 = enabled
Drain mode	A	5	0 = disabled      1 = enabled
Invert drain signal	A	6	0 = normal      1 = inverted
Levels disable	A	7	0 = levels      1 = no levels
System reset timer	A	8	0 – 75 minutes
* Formula disable	Various	F	0 = enable      1 = disable

NOTE: The pump time LED must be flashing when setting all features above, except formula disable.

\* Delay time LED must be flashing when setting the formula disable feature (only).

 **CAUTION:** The On-Premise Plus system has high voltage connected to the transformer. Always disconnect main power when servicing the unit.

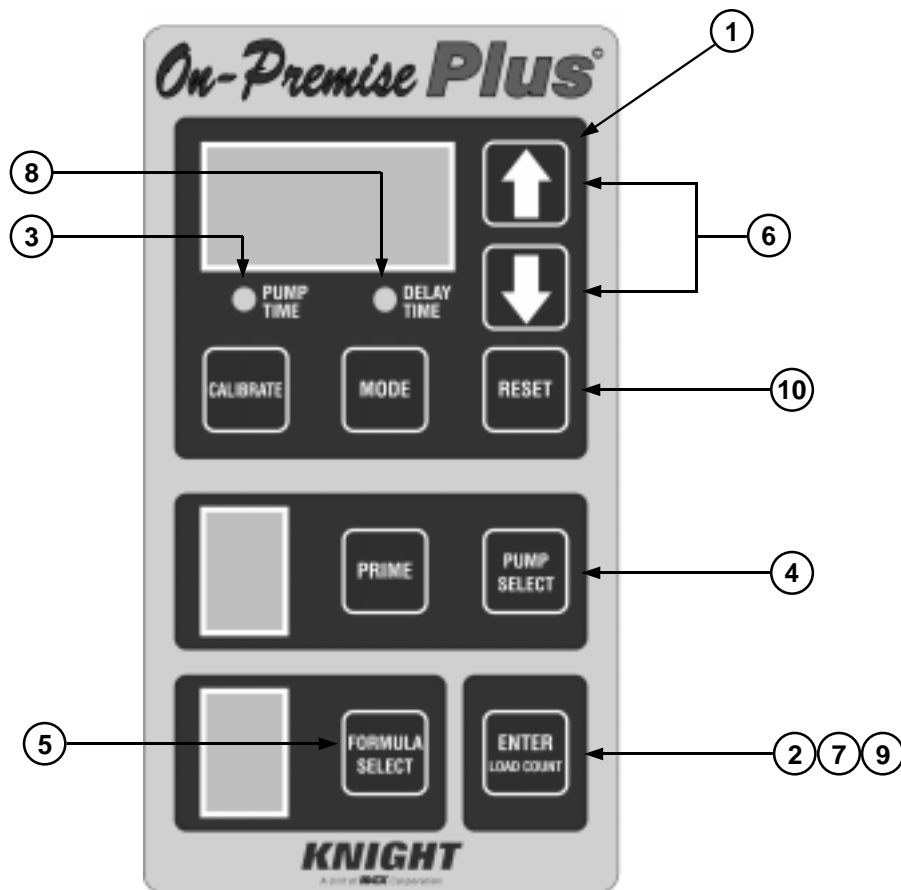

## QUICK-START PROGRAMMING

The steps below will give you just the basics to quickly setup a new system — more details and complete programming information are included in the following pages of this manual.

- (1) Press  $\hat{\uparrow}$  once (for default 000 access code).
- (2) Press ENTER...“ACC” will flash briefly on the display. You now have access.
- (3) Note that the pump time LED will be flashing.
- (4) Press pump SELECT until desired pump number is displayed.  
NOTE: If using a flush manifold, program pump “F” on all formulas to set flush time.
- (5) Press formula SELECT until desired formula number appears.
- (6) Use  $\hat{\uparrow}/\hat{\downarrow}$  to input the pump time or flush time (or delay time) in seconds.
- (7) Press ENTER...the display will flash indicating that your entry has been saved.
- (8) To program a pump delay time, press MODE until delay time LED is flashing. Repeat steps 4 – 7.
- (9) To set the load count pump, press ENTER twice (note that pump time & delay time LED's turn off). Use pump SELECT to choose the pump number that will be used to count loads for each formula. After a few seconds, the pump time LED will return, indicating that your entry has been saved.
- (10) Press RESET when finished programming and ready to run.

## INTRODUCTION

The On-Premise Plus was designed to meet today's laundry chemical injection needs with economy and flexibility in mind. Advanced microprocessor technology makes the OP-Plus one of Knight's least expensive laundry injectors, yet has all the features to meet every type of on-premise laundry condition.

The On-Premise Plus is a three component system, with each component performing a specific function. See diagram below for illustration of the following:

- (1) The **Signal Interface Module (SIB)** receives supply signals from the washmachine.
- (2) Signals are routed to the **Remote Control** which controls all timing and programming functions. Pump run times and delay times are activated for the selected formula number.
- (3) The output circuit board located inside the pump cabinet then runs the pumps for the correct amount of time.

Components utilize "Plug & Play" connections for easy installation.

## FEATURES

- 8 formula capability for various soil conditions
- Independent pump run times to provide specific volume injections
- Individual delay times for all wash formulas gives greater flexibility with "fixed" timer washwheels
- All programmed data is stored in a non-volatile memory which cannot be altered by voltage spikes or power outages.
- Optional Drain Mode and Relay Mode
- Formula and level enable/disable capability
- Flush mode can be used with all modes of operation
- Optional case mount flush manifold with solenoid provides single line diluted chemical injection
- LED display on the remote control let the user know which pump is running, and which formula is active
- The signal input circuitry will accept and verify a signal that is in the range of 24 to 240 volts.

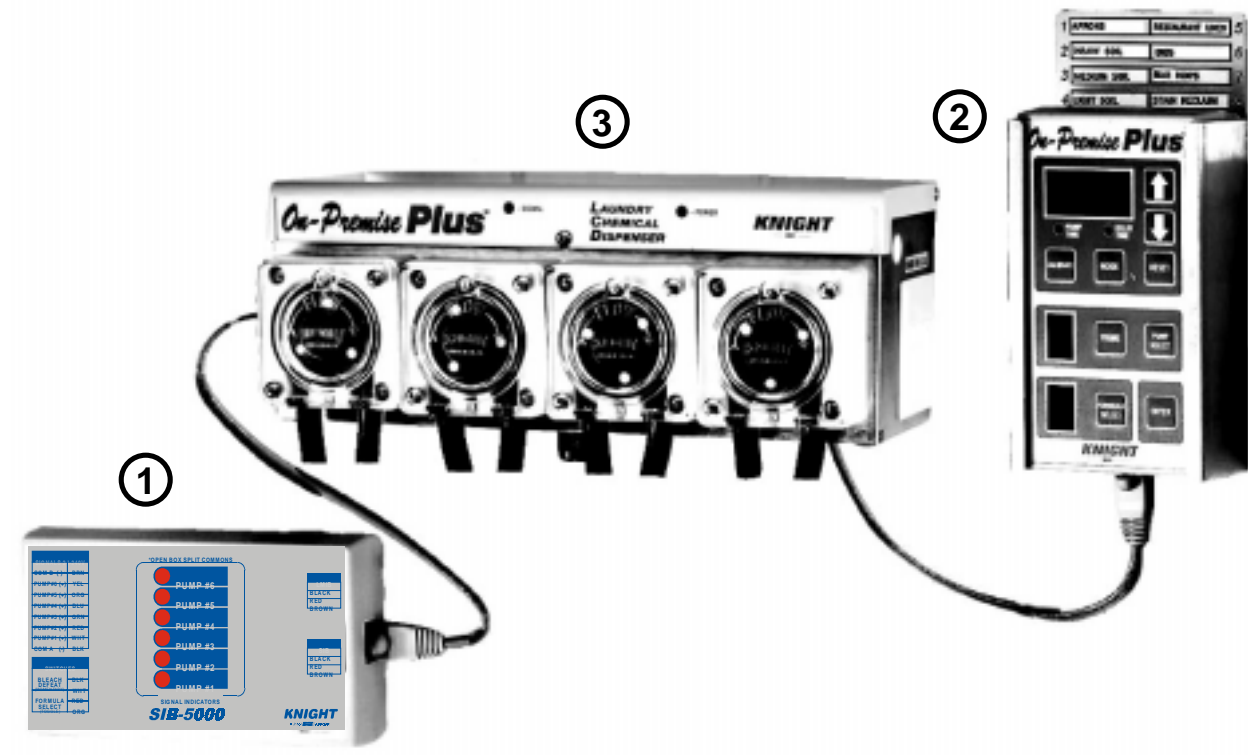

## PRE-INSTALLATION

Before the equipment is installed, you should survey the installation site thoroughly. At the very least, your survey should include the following:

- Check to make sure that all functions of the washmachine are operating properly. Including; card reader or timer, water solenoids, flush down valves, water level switch, machine motor, and drain valve.
- Check the proposed location for a 115, 208, or 230 VAC power source.
- Check voltage of all supply signals that will be used from the washmachine. Measure voltage between supply signal and signal common with a voltmeter. DO NOT check signal voltage between supply signal and case (earth) ground.
- Measure the distance from chemical supply containers to pump housing, and from pump housing to injection point inside washmachine.

## INSTALLATION

### (1) Disconnect all power to washer.

- (2) Mount pump cabinet in a convenient location no higher than 8' above, and within 10' horizontally, of supply containers. This is usually near the washer, however dispenser can be mounted as a remote pumping system.
- (3) Using the provided mounting bracket, mount the **Remote Control** to the front of the washer where operators can easily access it. Secure the bracket to washer using provided mounting screws or Dual-Lock fastening strips (be sure to first clean the mounting surface as the adhesive will not stick to a dirty surface). Connect the low voltage cable from the remote to the pump cabinet.
- (4) Connect 115, 208, or 230 VAC power source to main power connection in pump cabinet. Use suitable conduit for electrical wiring (per applicable wiring codes). NOTE: Low voltage Plug & Play cables do not require conduit.
- (5) Install and wire the **Signal Interface Module (SIB)** per notes to the right.
- (6) For each pump, cut the suction tube to length and insert one end into the appropriate supply container using PVC pipe as a support. Insert other end of suction tube into the left (input) side of the pump's squeeze tube.

- (7) For each pump, cut the discharge tube to length and insert one end into the right (output) side of the pump's squeeze tube. Form an anti-siphon loop (pointing "down") with the other end of discharge tube and insert into the supply pocket of the machine.
- (8) The system is now ready to be powered up and programmed.

### **The Signal Interface Module (SIB):**

The SIB receives supply signals from the washer, then communicates with the dispenser to run the pumps. The low voltage Plug-n-Play cable allows a quick, clean connection from the module to the pump system without requiring conduit.

- (1) Mount the module using the provided Dual Lock adhesive strip. The module can be mounted inside the washer's controls, along side the washer's controls, or to the bottom of the pump cabinet.
- (2) Connect the low voltage cable from the module to the OP-Plus pump system.
- (3) Connect the supply signals to the SIB per wire colors on the SIB label. If using Drain Mode, only one signal is required (pump #1).
- (4) If you have one signal common (typical) connect the common to "COM A" on the SIB. If you have two signal commons, you will need to remove a resistor inside the SIB before connecting the common wires! See the following details.

### **Splitting signal commons:**

- (1) Remove the four screws from the bottom of the SIB to open the module.
- (2) Locate the three resistors marked R1, R2, and R4, on the left side of the module (each resistor has a single black band).
- (3) Cut and remove the resistor that will "split" the commons between the desired pumps. Be sure to remove only one resistor.

CUT RESISTOR	TO USE COM A FOR PUMPS	AND COM B FOR PUMPS
R2	1, 2	3, 4, 5, 6
R1	1, 2, 3	4, 5, 6
R4	1, 2, 3, 4, 5	6

- (4) Close the module and replace the four screws when finished.

---

## OPERATING MODES

### **Normal operation:**

The system is capable of 8 user selectable formulas with each formula having unique run times and delay times for each pump. Signals from the washer trigger the pumps, then the On-Premise Plus' microprocessor takes control to count down delay and/or run times.

The machine operator, will select the formula by referring to a chart (provided with the On-Premise Plus). The operator then uses the formula SELECT button to choose the appropriate wash formula before the washcycle begins.

The first time pumps 1 - 6 are signaled, they will run "level" 1. The next time these pumps are signaled in the same formula, they will run "level" 2 providing that any signal lockout time (if used) has expired. Pumps 1 - 6 will not run again until the Load Count Pump is signaled, formula number changed, or the RESET button is pressed.

- No more than 2 pumps (if applicable) should be programmed to run simultaneously.
- Pumps 1 - 6 are the only pumps with "two level" capability. Level 1 can be "skipped over" if desired, by not programming any pump run time for that level. When the first signal is applied, no pump action will occur — the second signal will then activate the second level as usual.

### **Flush mode:**

The Flush Pump turns on with any pump running, then activates its own programmed run time when the pump shuts off. The system "looks" for contact at the flow switch terminals (see wiring diagram) to verify proper flush. If a flow switch is not used, jumper JP1 should be in place. A "flush error" happens when no contact is detected (switch or jumper) at the flow switch terminals while only the Flush Pump runs. Flush errors are indicated by the Remote Control flashing and "F" in the pump window. Also, the buzzer (optional) will sound.

Programming pump "F" is only required for systems that will inject with a flush manifold.

### **Relay mode:**

The intended use of relay mode is for machines that are microprocessor controlled. The pumps run for as long as their respective signals are present. The system "bypasses" its run time and delay time capabilities during relay mode operation.

Formula numbers are not selectable in relay mode (as they are not needed) — an "r" will be displayed in the formula number window indicating the system is in relay mode. Flush mode can be used in relay mode if chemicals are to be flushed with water to the washer.

To set relay mode, enter the access code, then use FORMULA SELECT to choose formula "r". Set the load count pump as explained in the Load Count section.

**(Note:** There is a one second qualifying time in relay mode. For the pump to run for 10 seconds the signal must be set for 11 seconds.)

### **Drain mode:**

Drain Mode maximizes the versatility of the OP-Plus by providing a simple and reliable signal interface to washers that do not have typical supply signal connections, or where the washer's supply signals are not operating correctly.

Installation time is quicker, as there is only one signal source required from the washer for Drain Mode to operate. See page 11 for complete details.

---

## PROGRAMMING

Before programming, please read the following important notes.

- The **access code** must be entered to program, prime pumps, or clear memory.
- **Pump “F”** is the flush pump. Programming pump “F” is only required when using a flush manifold.
- **Formula “A”** is not a chemical formula. It is only used for storing the access code, setting signal lockout time, setting system lockout time, setting delay units, pump 7 & 8 enable/disable, setting drain mode, and pump level enable/disable.
- **Formula “r”** indicates relay mode operation. See the Operating Modes section for details.
- You must set a **“load count pump”** for the system to operate correctly. See the Load Counts section for details.
- **Pumps 1 - 6** have a second “level” feature that allows two different injection amounts during a formula. See Normal Operation section for details. Pump numbers and their corresponding second level are as follows:

Pump:	1	2	3	4	5	6
Level:	A	B	C	D	E	0

### Access Codes:

A personal access code in the On-Premise Plus prevents unauthorized personnel from changing run times which could result in emergency service calls. No timing or formula features can be programmed without knowledge of the access code.

Each On-Premise Plus shipped from the factory has a default access code of 000. The code should be changed to a number which only the programmer knows. When you change the access code, keep a record of your new access code in a safe location.

The On-Premise Plus is designed to disable access if a pump is signaled, or if the system is left unattended for a few minutes. If you lose access, simply re-enter your access code and continue where you left off.

### Entering the access code:

Do not access the system while pumps are being signaled from the washer. Use whichever of the following two procedures that applies.

- If the system is new, or has not yet had the access code changed from the factory default of 000, press  $\uparrow$  once, then ENTER. The 3-digit display will flash “ACC” briefly, the pump time LED will begin flashing, and the number 1 will appear in the pump and formula displays.
- If the system has had the access code changed from the factory default of 000, use  $\uparrow/\downarrow$  to input your code, then ENTER. The 3-digit display will flash “ACC” briefly, the pump time LED will begin flashing, and the number 1 will appear in the pump and formula displays.

If the display does not flash “ACC” you do not have access to the system. Try entering your code again. If you are still unable to gain access after a few tries, contact Knight Technical Services (800-854-3764).

### Clearing the memory:

When installing a new system, or re-installing an old system, it is recommended that memory be cleared prior to programming.

- (1) Enter access code.
- (2) Hold down the  $\downarrow$  and FORMULA SELECT buttons simultaneously until display is blank.
- (3) The display will stay blank for about 3 minutes, then return to normal when complete.

After clearing memory, the access code will revert to 000, pump times/delay times will be erased, and all settings will revert to default state.

### Changing the access code:

For security, the access code should be changed from the factory setting of 000. Choose a number between 0 - 255 that you will easily remember.

- (1) Enter access code per previous instructions.
- (2) Select pump 1, and formula A.
- (3) Use  $\uparrow/\downarrow$  to input the new code, then ENTER. You can hold down on the arrow button if you wish to rapidly advance the numbers.
- (4) The display will flash briefly, indicating that the new access code was accepted.

---

### **Priming the pumps:**

- (1) Enter the access code if you do not already have access to the system.
- (2) Ensure that the pump time LED is flashing. If the delay time LED is flashing, press MODE to choose pump time.
- (3) Choose the pump with the PUMP SELECT button. Use whichever of the following two procedures that applies.
  - If pump run times are not yet programmed, press CALIBRATE to manually start/stop pump.
  - If pump run times are already programmed, press PRIME to activate the run time for the pump and formula presently selected. This can also be used to verify if the programmed run time will dispense the correct formula volume. Press RESET if the pump must be stopped during this prime function.

### **Calibrating pump run times:**

For this procedure, you will want to use a large container that has volume markings, such as a beaker, or graduated cylinder.

- (1) Ensure the pickup and delivery lines are primed.
- (2) Enter the access code if you do not already have access to the system.
- (3) Ensure that the pump time LED is flashing. If the delay time LED is flashing, press MODE to choose pump time.

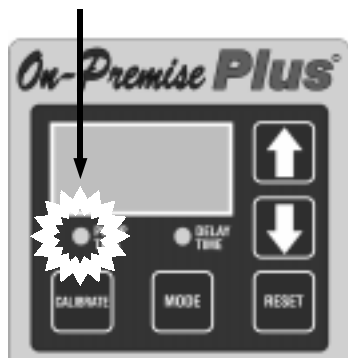

- (4) Choose the desired pump and formula using their respective SELECT buttons.
- (5) Position your container below the output of the pump you selected, then press CALIBRATE. The pump will run and the 3-digit display will begin counting.
- (6) When you have reached the desired volume in your container, press CALIBRATE again. The pump will stop, and the 3-digit display will show the time it took to pump the volume.
- (7) Press ENTER and the display will flash briefly, indicating that the pump time was accepted.

### **Manually programming pump run times:**

- (1) Enter the access code if you do not already have access to the system.
- (2) Ensure that the pump time LED is flashing. If the delay time LED is flashing, press MODE to choose pump time
- (3) Choose the desired pump and formula using their respective SELECT buttons.
- (4) Use  $\hat{\uparrow}/\hat{\downarrow}$  to input a new pump time or to change an existing pump time (if a pump time is already programmed, it will show up in the 3-digit display when you press  $\hat{\uparrow}/\hat{\downarrow}$ ). You can hold down on the arrow button if you wish to rapidly advance the numbers.
- (5) Press ENTER and the display will flash briefly, indicating that the pump time was accepted.



### Selecting delay time units:

Pump delay times can be set in one second increments for 0 - 255 seconds, or one minute increments for 0 - 99 minutes. Determine the longest delay time required for the system, and select the appropriate delay time units.

- (1) Enter the access code if you do not already have access to the system.
- (2) Select pump 3, and formula A.
- (3) Use  $\uparrow$  to choose 001 (seconds) or 060 (minutes) on the 3-digit display, then ENTER.

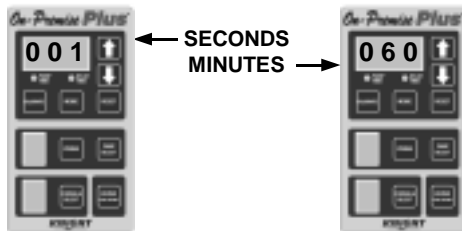

- (4) The display will flash briefly, indicating that the delay unit selection was accepted.

### Programming pump delay times:

- (1) Enter the access code if you do not already have access to the system.
- (2) Ensure that the delay time LED is flashing. If the pump time LED is flashing, press MODE to choose delay time.
- (3) The 3-digit display will show  $\bullet\bullet\bullet$  if delay units are in "seconds" or will show  $- \bullet\bullet$  if delay units are in "minutes".
- (4) Choose the desired pump and formula using their respective SELECT buttons.
- (5) Use  $\uparrow/\downarrow$  to input a new delay time or to change an existing delay time (if a delay time is already programmed, it will show up in the 3-digit display when you press  $\uparrow/\downarrow$ ). You can hold down on the arrow button if you wish to rapidly advance the numbers.
- (6) Press ENTER and the display will flash briefly, indicating that the delay time was accepted.

NOTE: During delay time countdown  $- \bullet\bullet$  will display indicating a countdown in one minute increments. If programmed to delay in one second increments, the display will count down from the delay time to zero.



### Programming flush times:

See Flush Manifold instruction manual for installing Flush Manifold with dispenser.

- (1) Enter the access code if you do not already have access to the system.
- (2) Dispense a small amount of **colored** chemical into manifold.
- (3) Choose pump F and the desired formula using the pump and formula SELECT buttons.
- (4) Ensure that the pump time LED is flashing. If the delay time LED is flashing, press MODE to choose pump time.
- (5) Press CALIBRATE. The flush solenoid will activate and the 3-digit display will begin counting.
- (6) Once all **colored** product has been cleared from the line to the washer, press CALIBRATE again to stop the water flush. The display will stop counting and the 3-digit display will show the time it took to flush line.
- (7) Press ENTER and the display will flash briefly, indicating that the flush time was accepted.
- (8) Repeat this procedure for each formula used, or simply note the flush time from step 6, and manually enter this time for pump F on each formula used.

---

## LOAD COUNTS

The load count pump of the On-Premise Plus performs a number of important functions.

- Counts the loads for all formulas used
- Terminates signal lockout time
- Resets "levels" for pumps 1 - 6 (the selected load count pump can only have 1 wash level)
- Starts the system reset timer

Select the last pump that will receive a signal during any wash formula. **The load count pump must receive a signal at the end of each formula.** A signal should be received even if the pump will not dispense chemical for the selected formula.

Choosing the proper load count pump is critical when using Drain Mode to maintain proper injection sequence. When drain mode is enabled, the load count pump will default to pump #7. This can be changed to a different pump number, if desired. Normally you will set the load count pump to correspond with the last drain signal that will be received during the formula, however there may be additional drain signals that occur after the last pump has injected. See the Drain Mode section for more details.

### **Setting the load count pump:**

- (1) Enter the access code if you do not already have access to the system.
- (2) Press ENTER twice. The pump time and delay time LED's will be off and the current load count pump will be displayed in the pump window for a few seconds. If the pump time and delay time LED's are not off, repeat this step.
- (3) Use PUMP SELECT to choose the load count pump number. Do not use pump A through F. The display will "flash while you are selecting the load count pump (this is normal).
- (4) After a few seconds the pump time LED will return, indicating the pump number was accepted.
- (5) If the pump time LED returns before the desired pump has been chosen, repeat steps 2 & 3.

### **To view/clear formula load counts:**

Entering the access code is not required for this function. This allows laundry room managers or operators to check load counts, and reset them at the interval of their choosing, without the possibility of changing pump programming.

The following steps are for normal operation only.

- (1) Press ENTER. The pump time and delay time LED's will be off, and the load count will be shown on the 3-digit display for the current formula number.
- (2) Use FORMULA SELECT to view load counts for other formulas while the pump time and delay time LED's are off (**formula 0 shows a cumulative total for all formulas**).
- (3) After a few seconds, the display will flash and return to its previous appearance.
- (4) To clear formula load counts, press ↓ while the count is being shown until 000 appears on the 3-digit display. Do this for all formulas, including formula 0. If the display flashes before the count was cleared, repeat this step.

The following steps are for drain mode only.

- (1) Use FORMULA SELECT until desired formula number is displayed.
- (2) Press ENTER. The pump time and delay time LED's will be off, and the load count will be shown on the 3-digit display for the current formula number.
- (3) After a few seconds, the display will flash and return to its previous appearance. Repeat steps 1 & 2 for all formulas you wish to view.
- (4) To clear the formula load count, press ↓ while the count is being shown until 000 appears on the 3-digit display. Do this for all formulas. If the display flashes before the count was cleared, repeat this step.

---

## DRAIN MODE

Drain mode counts the number of times the drain solenoid is energized during the machine's operating cycle, and chemicals are injected by their programmed (assigned) drain number.

Activation of the "load count pump" ends the current formula and prepares the OP-Plus to run the next washcycle. Pump 7 is the default load count pump when using drain mode. For each formula, pump 7 should be assigned to the final drain number. This ensures the formula is properly ended, even on machines where the drain signal occurs again after the last chemical injection.

- Connect the machine's drain signal to pump 1 input on the signal interface module (SIB).
- Program chemical formulas according to the instructions on pages 8 – 9. Pumps can have a second injection "level" if required, however the second level should be assigned to a later drain number than the first.
- Program the flush time (if manifold is used).
- During operation, the upper display will show the current drain count. This is signified by the letter "d" as the first character of the display.

### Enabling or disabling drain mode:

- (1) Enter the access code if you do not already have access to the system.
- (2) Select pump 5, and formula A.
- (3) Use  $\uparrow$  to choose 000 (disable) or 001 (enable) on the 3-digit display, then ENTER.

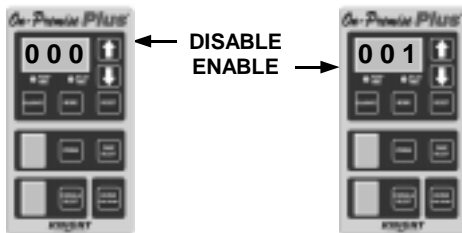

- (4) The display will flash briefly, indicating that the enable/disable status was accepted.

### Assigning drain numbers:

- (1) Enter the access code if you do not already have access to the system.
- (2) Press MODE until both the pump time and delay time LED's are flashing.
- (3) Select the formula and pump.
- (4) Use  $\uparrow/\downarrow$  to input the drain number, or to change an existing drain number (max is 15). Multiple pumps can run on any drain occurrence, however you may wish to use delay times to "stagger" the pumps operation.
- (5) Press ENTER and the display will flash briefly, indicating that the drain number was accepted.
- (6) Repeat steps 3 – 6 for all formulas and pumps that will be used.

### Inverting drain mode signal:

The washer's drain mechanism will typically energize the solenoid to close the drain and de-energized to open the drain. This type of drain activation is standard on almost every Wascomat, Milnor and Uni-Mac washer, however Drain Mode can be set to recognize an "inverted" signal (one that energizes to open the drain) if necessary.

- (1) Enter the access code if you do not already have access to the system.
- (2) Select pump 6, and formula A.
- (3) Use  $\uparrow$  to choose 000 (normal) or 001 (inverted) on the 3-digit display, then ENTER.

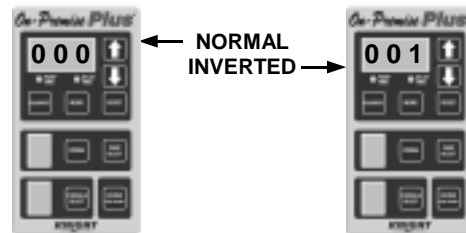

- (4) The display will flash briefly, indicating that the normal/inverted status was accepted.

---

## OTHER FEATURES

### Setting signal lockout time:

Signal lockout is an optional feature that can be used to prevent unwanted injections when unwanted supply signals are received multiple times during a washcycle. Signal lockout is not recommended for drain mode operation.

The lockout time is selectable from 0 – 75 minutes, and starts counting down when a pump finishes running. Any signals received for that pump will be disregarded during the “count down” period. Any lockout time that may still be counting down when the load count pump activates will be terminated in preparation for the next formula.

- (1) Enter the access code if you do not already have access to the system.
- (2) Select pump 2, and formula A.
- (3) Use  $\uparrow/\downarrow$  to input the signal lockout time from 0 – 75 minutes, then ENTER. You can hold down on the arrow button if you wish to rapidly advance the numbers.
- (4) The display will flash briefly, indicating that the signal lockout time was accepted.

### Enabling or disabling pumps 7 & 8:

If the circuit board in the dispenser has less than 8 pump outputs, pumps 7 & 8 should be disabled. A new dispenser from the factory will already have these pumps disabled. Also, when clearing the memory pumps 7 & 8 are disabled by default.

- (1) Enter the access code if you do not already have access to the system.
- (2) Select pump 4, and formula A.
- (3) Use  $\uparrow$  to choose 000 (disable) or 001 (enable) on the 3-digit display, then ENTER.

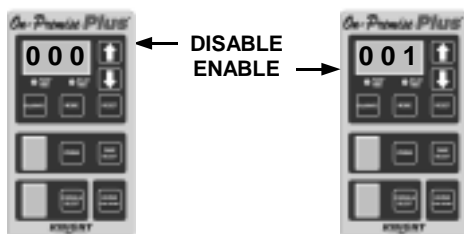

- (4) The display will flash briefly, indicating that the enable/disable status was accepted.

### Level enable/disable:

This feature allows you to disable or “over-ride” the second level injection sequence used in normal operation. When levels are disabled, the pumps will repeat their injections on any subsequent signals from the washmachine, providing that the pump is not counting down a lockout time.

Disabling levels may be helpful in accounts where the load count signal from the washer is inadvertently skipped from operator error, or machine error. It can prevent a missed injection in such situations.

This feature is not needed for relay mode or drain mode operation

- (1) Enter the access code if you do not already have access to the system.
- (2) Select pump 7, and formula A.
- (3) Use  $\uparrow$  to choose 000 (levels) or 001 (no levels) on the 3-digit display, then ENTER.



- (4) The display will flash briefly, indicating that the enable/disable status was accepted.

---

### System reset timer:

The system can be programmed to delay the reset for up to 75 minutes after the load count pump starts. This is useful where the system may receive extra signals in the final rinse or extract cycles (common on smaller European machines).

To set the timer:

- (1) Enter the access code if you do not already have access to the system.
- (2) Select pump 8, and formula A.
- (3) Ensure that the pump time LED is flashing. If the delay time LED is flashing, press MODE to choose pump time.

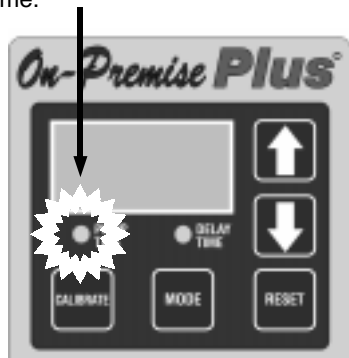

- (4) Use  $\uparrow/\downarrow$  to set the desired reset time. You can hold down on the arrow button if you wish to rapidly advance the numbers.
- (5) Press ENTER and the display will flash briefly, indicating that the reset time was accepted.

### Formula enable/disable:

This feature allows you to choose only those formula numbers that you want visible to the operator for selecting the chemical formula from the On-Premise Plus remote control. This makes the remote control more user-friendly to the operators, and eliminates the chance of missed chemical injections due to inadvertently choosing an unused formula.

By default (for a new dispenser or after clearing memory) the formula enable feature is reset and all formula numbers are visible. If you wish to "turn off" (disable) certain formulas, they will not be visible to operators but will appear when the control is accessed for programming.

To enable or disable a formula:

- (1) Enter the access code if you do not already have access to the system.
- (2) Select pump F.
- (3) Ensure that the delay time LED is flashing. If the pump time LED is flashing, press MODE to choose delay time.

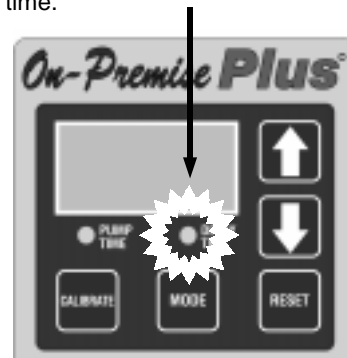

- (4) Select the formula number that you wish to enable or disable.
- (5) Use  $\uparrow$  to choose 000 (enable) or 001 (disable) on the 3-digit display, then ENTER.
- (6) The display will flash briefly, indicating that the enable/disable status was accepted.
- (7) Repeat steps 3 – 5 for all formulas that you wish to disable.

NOTE: If you inadvertently disable all formulas, the control will automatically enable formula 1 so there will at least be one available formula.

---

## TROUBLESHOOTING

### ***Remote control does not light up - power indicator does not come on:***

- Check fuses, on circuit board inside dispenser and inline with xfmr — replace if necessary.
- Check voltage at power input terminals inside dispenser — refer to wiring diagram.

### ***Pumps do not trigger from signals:***

- Check signal voltage and duration.
- Check for flush error — press RESET to clear.
- Check pump run and delay time settings.
- Pump may be counting down a "lockout" time (if used) from a previous activation.
- Pump may be trying to activate its "second level" feature (this applies to pumps 1 - 6 only).
- System may be set for Drain Mode, which requires pumps to have a drain number assignment to activate.

### ***Pumps will not turn when trying to prime, or during a washcycle:***

- Check for loose pump motor wires.
- Check for voltage from circuit board to motor.
- Check for mechanical binding of moving parts.

### ***Flush errors keep occurring:***

- Check to see if a flush manifold is used — if so, is it operating correctly?
- Check flow switch for proper connection to dispenser and proper water flow. Jumper JP1 should be set if a flow switch is not used.
- Press RESET to clear flush errors — pumps will not run during flush error.

### ***Pumps run but do not dispense product:***

- Check product containers.
- Check squeeze tube for wear.
- Check condition of roller and pump housing.
- Check for air leaks) on suction line.
- Check for blockage from pump tube into flush manifold (if used).

### ***Pumps trigger more than once during cycle:***

- Check supply signal input for repeat signals from washmachine.
- Check signal lock-out function.
- If drain mode is used, verify if a second level is programmed.

### ***All pumps run at the same time.***

- Check signals from washmachine.
- May be using relay mode with drain mode enabled.

# SYSTEM WIRING DIAGRAM

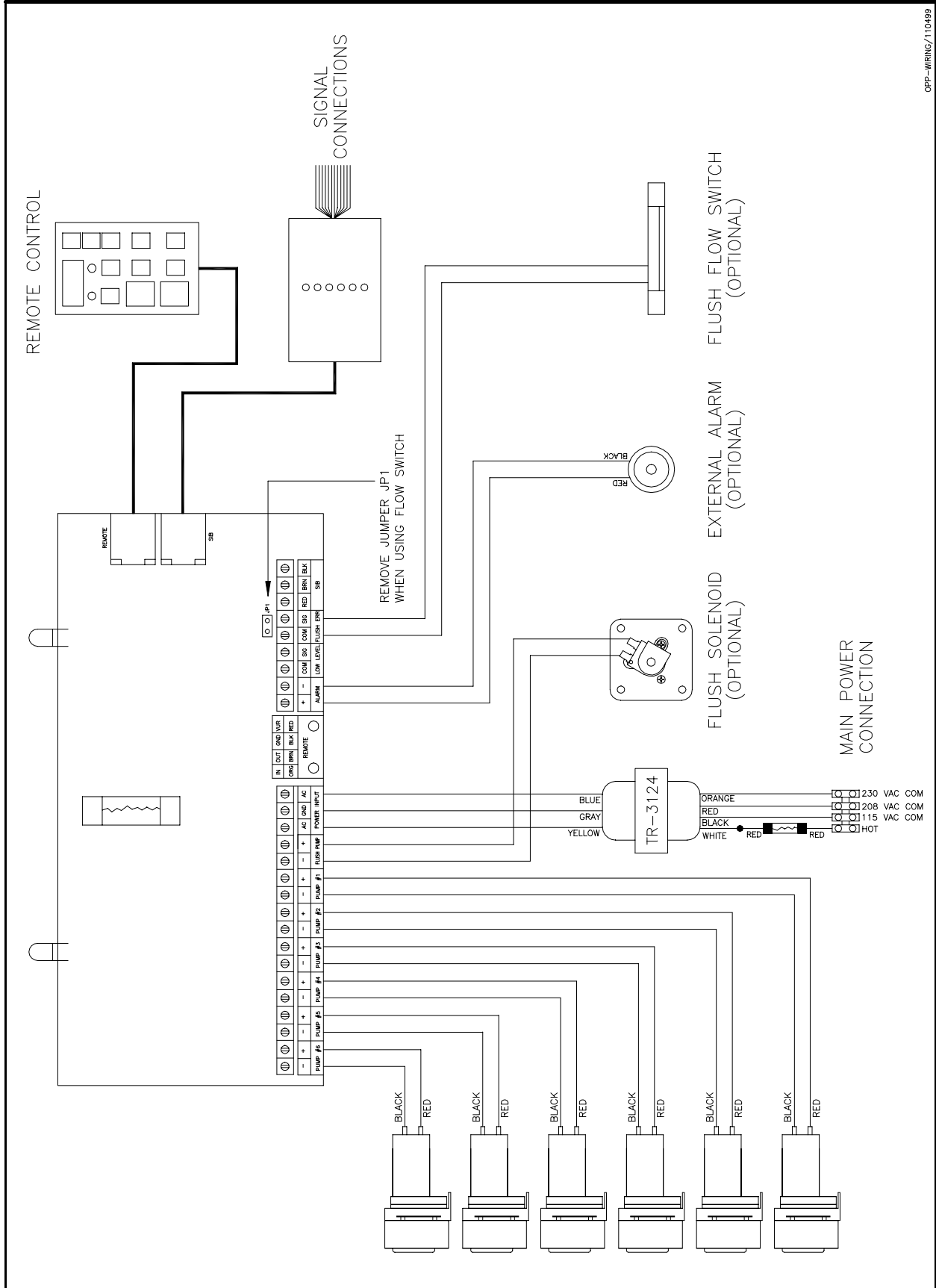

OPP-WIRING/110499

---

## DISCLAIMER

Knight Inc. does not accept responsibility for the mishandling, misuse, or non-performance of the described items when used for purposes other than those specified in the instructions. For hazardous materials information consult label, MSDS, or Knight Inc.

## WARRANTY

All Knight controls and pump systems are warranted against defects in material and workmanship for a period of ONE year. All electronic control boards have a TWO year warranty. Warranty applies only to the replacement or repair of such parts when returned to factory with a Knight Return Authorization (KRA) number, freight prepaid, and found to be defective upon factory authorized inspection. Bearings and pump seals or rubber and synthetic rubber parts such as "O" rings, diaphragms, squeeze tubing, and gaskets are considered expendable and are not covered under warranty. Warranty does not cover liability resulting from performance of this equipment nor the labor to replace this equipment. Product abuse or misuse voids warranty.

### ***KNIGHT INC.*** A Unit of IDEX Corporation

**World Headquarters: 20531 Crescent Bay Drive, Lake Forest, CA 92630-8825 (USA) TEL: 949-595-4800, FAX: 949-595-4801, [www.knightequip.com](http://www.knightequip.com)**

Atlanta Branch: 415 Gees Mill Business Court NE, Suite 200 Conyers, GA 30013 USA TEL: 770-760-8777 FAX: 770-761-0199	Toronto Branch: 2880 Argenta Road, Unit 6 Mississauga, Ontario L5N 7X8 Canada TEL: 905-542-2333 FAX: 905-542-1536	London Branch: #15 Brunel Centre Newton Road, Crawley West Sussex UK RH10 9TU TEL: 44-1293-615570 FAX: 44-1293-615585	Sydney Branch: Unit 28, 317-321 Woodpark Rd., Smithfield NSW Australia 2164 TEL: 61-29-725-2588 FAX: 61-29-725-2025	Amsterdam Branch: Marssteden 68 7547 TD Enschede The Netherlands TEL: 31-53-428-58-00 FAX: 31-53-428-58-09	Spain Branch: Port Ginesta, Local 210 08860 Sitges Barcelona Spain TEL: 34-936-342-130 FAX: 34-936-643-477
---	--	--	--	---	---